

KL4000 SERIES 100mm chart DOT-PRINTING TYPE HYBRID RECORDER



KL4000 Series hybrid recorders realize simple and easy operation as analog recorders. Not only can each measured value be read from the custom made analog scale plate which incorporates input type and measurement value input, but a comprehensive LED display also enables precise digital measurements to be taken by the user.



FEATURES

●Dual displays for accuracy and simplicity

Measured value can be read at a glance, directly from the triple scale analog display plate while a digital display clearly indicates measured values.

●Ready to run immediately after Power ON

As the recorders are pre-set to meet individual customer specifications and precise application requirements, the unit starts indicating and recording as soon as they are Power ON.

●Front section USB port provided

Connect with PC by mini-USB cable.* By attached setting software, you can set or change the parameter by PC. *Purchase commercialized product separately.

●Corresponds to custom-made

In addition to easy to use features, we will correspond to adding various devices and special features according to user's requirement.

●Packaged Software attached

- By Data acquisition software, the use of application is expands from recording/management to information processing.

*Optional communication interface is required.

- Parameter setting software can manage the setting information on PC.

MODELS

KL4 -

Input signal

- 1 : Thermocouple/DC voltage single range
- 2 : Resistance thermometer single range
- 5 : Thermocouple/DC voltage individual range
- 6 : Resistance thermometer/thermocouple/DC voltage individual range

Input point

06 : 6 points

Communication interface (option)

- N : None
- R : RS232C
- A : RS422A/RS485

Alarm output / remote contacts (option)

- 0 : None
- 2 : Mechanical relay 2 points ('a' contact)
- 4 : Mechanical relay 4 points ('c' contact)
+ remote contact 5 points
- A : Mechanical relay 6 points ('a' contact)
+ remote contact 5 points

Power supply

A : 100-240V AC

NAME

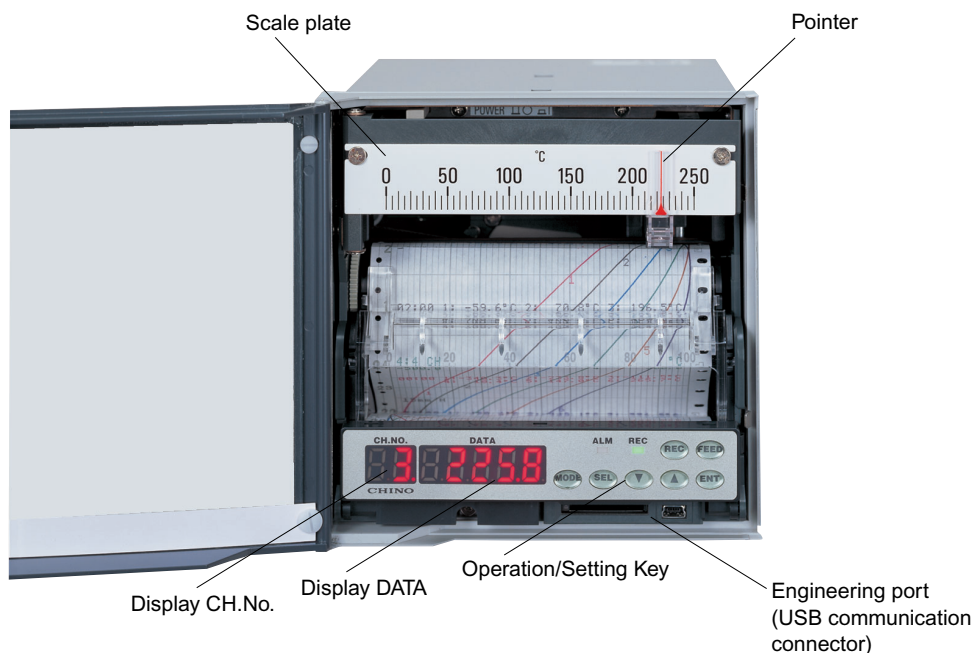

● Display and operation keys

[Display]

CH.No.	Channel number of analog indication and data display (data display only for one-point continuous display) *
DATA	Data or time display*

*Set contents are displayed while in [Setting mode].

[Status LED]

REC	Green light lights during recording. Operation of recording ON/OFF is done by REC key. Flashes when chart end.
ALM	ALM Red light blinks during alarm activation.

[Operation/set key]

Key names		Function
FEED	Feed key	Feeds chart at a speed of 600mm/min while this key is pressed.
MODE	Mode key	Switches mode.
SEL	Select key	Selects item to be set.
▼	Down key	Moves the cursor up/down.
▲	Up key	Selects setting items or values.
ENT	Enter key	Registers various settings.

RECORDING EXAMPLE

Periodic data printing and fixed time printing

Prints data(time, scale, chart speed periodic, setting change mark and printing of time line) on trace printing at arbitrary set intervals.

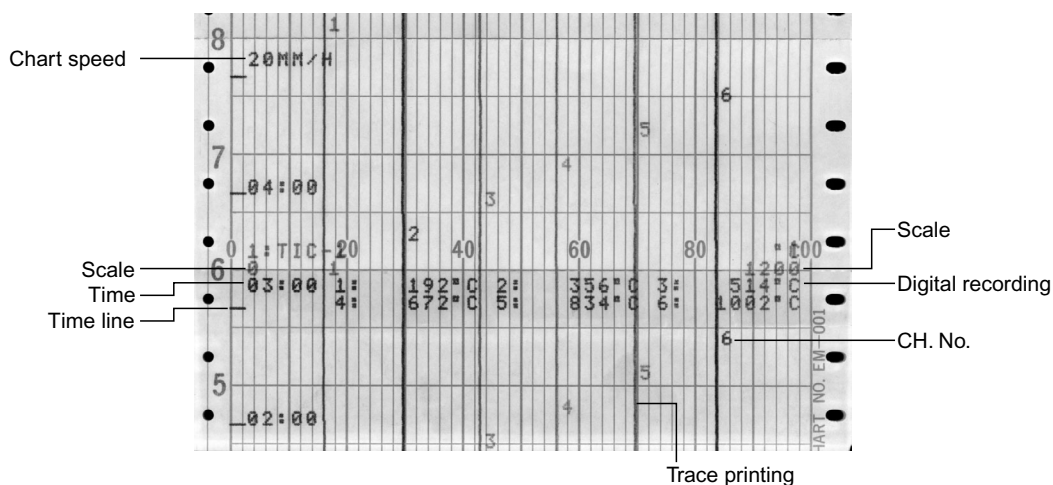

Data printing

When the latest data is required, trace printing will stop and record.

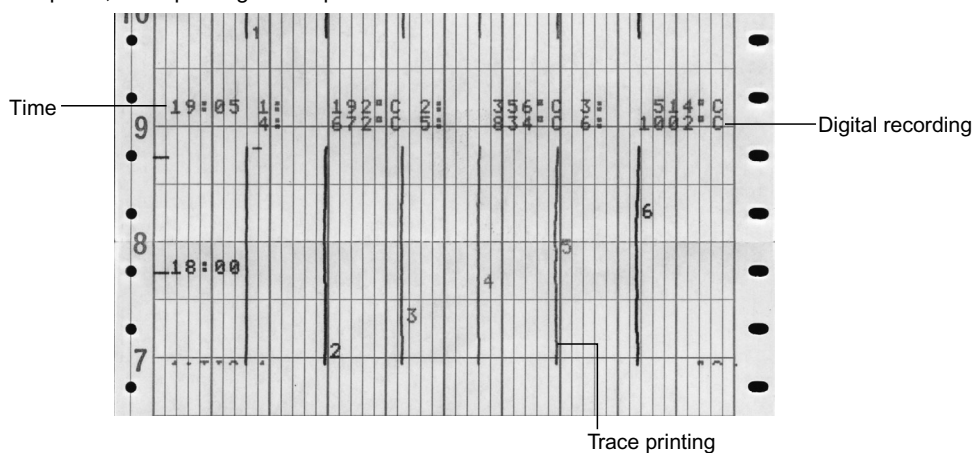

Alarm activation and reset printing

When an alarm activation and reset occurred, its time, CH No, alarm type and level are printed.

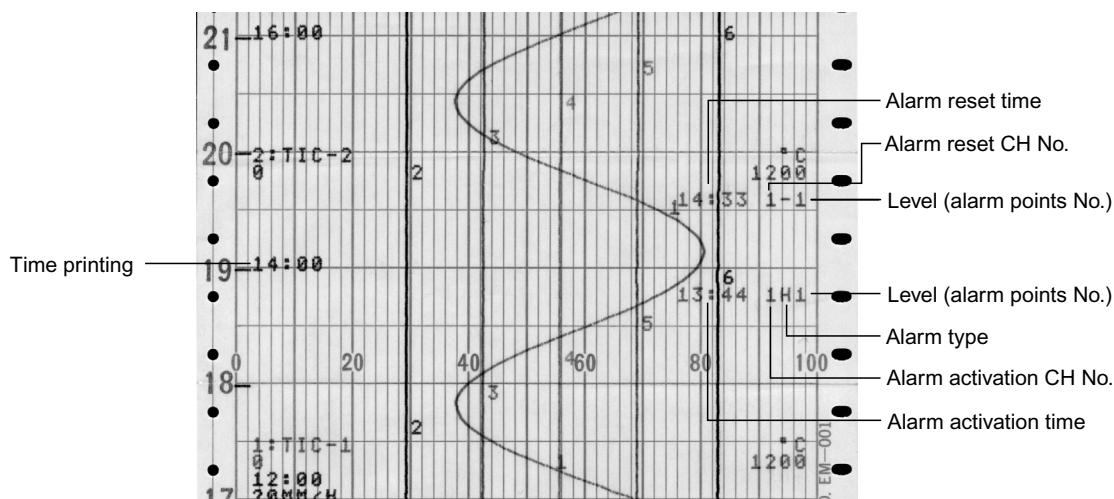

INPUT SPECIFICATIONS

Measuring points: 6
 Input types: DC voltage --- $\pm 6.9\text{mV}$, $\pm 13.8\text{mV}$, $\pm 27.6\text{mV}$
 $\pm 69.0\text{mV}$, $\pm 5\text{V}$
 DC current --- Max 50mA by external shunt resistor
 (100 Ω , 250 Ω) (sold separately)
 Thermocouple ---
 K, E, J, T, R, S, B, N, U, L,
 W-WRe26, WRe5-WRe26,
 PtRh40-PtRh20, NiMo-Ni,
 CR-AuFe, Platinel II
 Resistance thermometer ---
 Pt100, old Pt100, JPt100, Pt50,
 Pt-Co
 Accuracy ratings: Refer to the tables of measurement range,
 accuracy ratings and display resolution
 Measuring interval: 5sec./6points
 Reference junction compensation accuracy:
 At ambient temperature: $23^{\circ}\text{C} \pm 10^{\circ}\text{C}$
 K, E, J, T, N Platinel II ---
 $\pm 0.5^{\circ}\text{C}$ or equivalent of 20 μV ,
 whichever is greater
 Other than above ---
 $\pm 1.0^{\circ}\text{C}$ or equivalent of 40 μV
 thermal electromotive force,
 whichever is greater
 Burnout: For thermocouple input and resistance
 thermometer input this function detects input
 signal disconnection.
 For thermocouple, resistance thermometer this
 function enables selection of NON/UP/DOWN
 for each input CH
 Terminal board: Removable when wiring.

RECORDING SPECIFICATIONS

Dotting interval: About 5sec./1point
 Recording system: Wire-dot type 6-color ribbon
 Record/Printed color:

Trace printing

CH	1	2	3
Color	Red	Black	Blue
CH	4	5	6
Color	Green	Brown	Purple

Digital recording

Periodic data printing	Repetition of six colors; red, black, blue, green, brown and purple
Alarm printing	Activate: Red, Reset: Green
List printing	Black (individual channel items use same colors as trace printing)

Chart paper: Fan-fold type
 Total width 114mm, total length 10m, effective chart width 100mm
 Chart speed: From 1 to 1500mm/h, in 1mm/h increments.
 (12.5mm can be set exceptionally.)
 Periodic data printing: Digital printing is added to trace printing as time, channel no., data, and unit. Interval (hour, minute) arbitrary setting
 Data printing: When required, interrupt trace printing and digital print time and measuring value.
 Alarm printing: Alarm activated --- Time, CH No, alarm type and level are printed
 Alarm reset --- Time, CH No. and alarm level are printed
 List printing: Memory capacity --- Max. of 48 data
 When required, interrupt trace printing and print date, chart speed and setting information of each channel.
 Subtract printing: *Optional remote contacts is required.
 Difference between reference CH value and measured value or between set value and measured value (set by provided software)
 Fixed time printing: Date (month/day), time and time line, scale, CH No. tag and unit are printed in conjunction with the chart speed.
 Skip function: No display or printing of channels that are not inputted.

DISPLAY AND INDICATION SPECIFICATIONS

Analog display: 100mm scale plate
 Digital display: 7-segment type red LED,
 CH No, 2 digits and data display, 5 digits
 Status display: REC, ALM

ALARM SPECIFICATIONS

Alarm display: Status LED "ALM" flashes,
 Alarm types: Absolute upper/lower alarm, differential upper/lower alarm, rate-of-change upper/lower alarm
 Alarm settings: Each points individual settings, Max 2 levels/1 CH
 Alarm output: Mechanical relay 'a' contact 2 or 6points output
 Mechanical relay 'c' contact 4points output

GENERAL SPECIFICATIONS

Rated power voltage: 100 to 240V AC, 50/60Hz
 Power consumption: Max 38VA
 100VAC balanced 17VA, 240VAC balanced 23VA
 Normal operation condition:
 Ambient temperature range : 0 to 50 $^{\circ}\text{C}$
 (20 to 60%RH no dew condensation)
 Ambient humidity range: 20 to 80%RH,
 (5 to 45 $^{\circ}\text{C}$) no dew condensation
 Power voltage : 90 to 264V AC
 Power frequency : 50/60Hz $\pm 2\%$
 Mounting orientation : forward tilting 0 $^{\circ}$,
 backward tilting 0 to 30 $^{\circ}$,
 left/right 0 to 10 $^{\circ}$
 Case material: Door---Aluminum die casting (ADC12)
 Front plate---Soda glass
 Case---Steel (SPCC)
 Door frame---Black
 Case color: (equivalent of Munsell N3.0)
 Front plate---Clear and colorless
 Case---Gray (equivalent of Munsell N7.0)
 Mounting method: Panel flush-mount
 Weight: About 3.0kg (full option)

STANDARDS

CE marking: EN61326-1
 EN61010-1
 *Under EMC test condition, variation in indication value is $\pm 20\%$ or $\pm 2\text{mV}$ at maximum, whichever is larger.
 UL: UL61010-1
 CSA (C-UL): CAN/CSA C22.2 No.61010-1

OPTIONS

Other manufacture's chart paper corresponding type
 Handle and feet

ACCESSORIES

Shunt resistor for DC current	100 Ω Model : EZ-RX100 (Max.50mA)
	250 Ω Model : EZ-RX250 (Max.20mA)

● MEASURING RANGES/ACCURACY RATING/DISPLAY RESOLUTION

Input type	Measuring range	Accuracy ratings	Display resolution
DC voltage	mV	-6.9 to 6.9mV	±0.2% ±1digit 5μV
		-13.8 to 13.8mV	±0.1% ±1digit 10μV
		-27.6 to 27.6mV	
		-69.0 to 69.0mV	
	V	-5 to 5 V	10mV
Thermocouple	K	-150 to 150°C	±0.2% ±1digit 0.1°C
		-200 to 300°C	±0.1% ±1digit 0.1°C
		-200 to 600°C	
		-200 to 1370°C	
	E	-200 to 350°C	
		-200 to 900°C	
	J	-200 to 500°C	±0.1% ±1digit 1 °C
		-200 to 1200°C	
	T	-150 to 150°C	±0.2% ±1digit 0.1°C
		-200 to 250°C	±0.1% ±1digit 0.1°C
		-200 to 400°C	
	R	0 to 1760°C	
	S	0 to 1760°C	1 °C
	B	0 to 1820°C	1 °C
	N	-200 to 200°C	±0.2% ±1digit 0.1°C
		-200 to 400°C	±0.1% ±1digit 0.1°C
		-200 to 750°C	
	-200 to 1300°C		
	U	-150 to 150°C	±0.2% ±1digit 0.1°C
		-200 to 250°C	±0.1% ±1digit 0.1°C
		-200 to 500°C	
		-200 to 600°C	
	L	-200 to 900°C	
	W-WRe26	0 to 2315°C	1 °C
	WRe5-WRe26	0 to 2315°C	1 °C
	NiMo-Ni	0 to 1310°C	1 °C
	Platinel II	0 to 150°C	±0.2% ±1digit 0.1°C
		0 to 350°C	±0.1% ±1digit 0.1°C
0 to 650°C			
0 to 1390°C			
PtRh40-PtRh20	0 to 1880°C	±0.2% ±1digit 1 °C	
CR-AuFe	0 to 280 K	0.1K	
RTD	Pt100	-50 to 50°C	±0.1% ±1digit 0.1°C
		-100 to 100°C	
		-140 to 150°C	
		-200 to 300°C	
		-200 to 649°C	
	Old Pt100	-50 to 50°C	±0.1% ±1digit 0.1°C
		-100 to 100°C	
		-140 to 150°C	
		-200 to 300°C	
		-200 to 649°C	
	JPt100	-50 to 50°C	±0.1% ±1digit 0.1°C
		-100 to 100°C	
		-140 to 150°C	
		-200 to 300°C	
		-200 to 649°C	
	Pt50	-200 to 649°C	0.1°C
	Pt-Co	4 to 374 K	±0.15% ±1digit 0.1K

Note: The accuracy ratings are converted into the measuring range under reference condition. Thermocouple input does not contain reference junction compensation accuracy.

K, E, J, T, R, S, B, N : IEC584(1977, 1982), JIS C 1602-1995, JIS C 1605-1995

W-WRe26, NiMo-Ni, PlatinelII, PtRh40-PtRh20, CR-AuFe, Au/Pt : ASTM E1751

WRe5-WRe26 : ASTM E988 U, L : DIN43710-1985

Pt100 : IEC751(1995), JIS C 1604-1997

Old Pt100 : IEC751(1983), JIS C 1604-1989, JIS C 1606-1989

JPt100 : JIS C 1604-1981, JIS C 1606-1986, Pt50 : JIS C 1604-1981 Pt-Co : CHINO

APPLICATION SOFTWARE (standard attached)

Data Acquisition Software

You can acquire data easily to your PC.

*Optional communication interface required

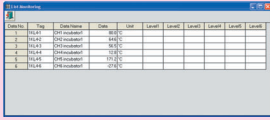

List Data Screen

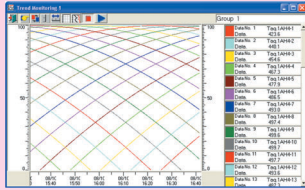

Trend Data Screen

Parameter Setting Software

Control the setting information at PC by using communication interface or USB port (standard equipped)

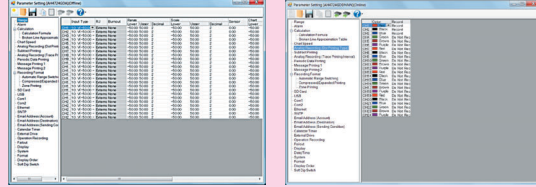

TERMINAL ARRANGEMENT

Alarm relay output(6 points 'a' contact) + remote contacts and communication interface

Communication terminal * RS232C and RS422A/485 are specified on purchase.

		1	2	3	4	5	6	7	8
COM1	RS232C				SG	SD		RD	
	RS422A				SG	SDA	SDB	RDA	RDB
	RS485				SG	SA	SB	SA	SB

Short between 5-7, 6-8

Measurement input terminals
TC-mV(+), RTD(A) terminals
TC-mV(-), RTD(B) terminals
RTD(B) terminals

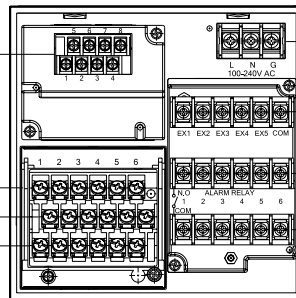

Power/protective conductive terminals

Remote contact terminals (option)

Alarm output terminals (option)

N.O terminal

COM terminal

Alarm relay output(4 points 'c' contact) + remote contacts and communication interface

Communication terminal * RS232C and RS422A/485 are specified on purchase.

		1	2	3	4	5	6	7	8
COM1	RS232C				SG	SD		RD	
	RS422A				SG	SDA	SDB	RDA	RDB
	RS485				SG	SA	SB	SA	SB

Short between 5-7, 6-8

Measurement input terminals
TC-mV(+), RTD(A) terminals
TC-mV(-), RTD(B) terminals
RTD(B) terminals

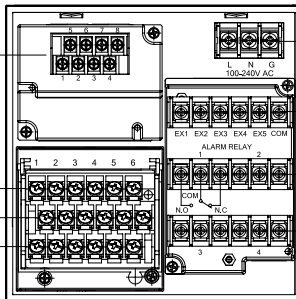

Power/protective conductive terminals

Remote contact terminals (option)

Alarm output terminals (option)

DIMENSIONS

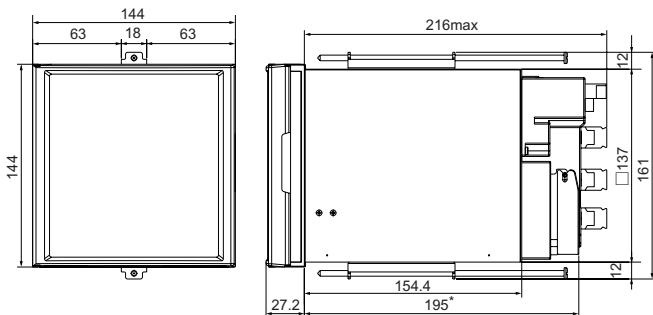

*Maximum 216 when an alarm unit and a communication unit are added

Panel cutout

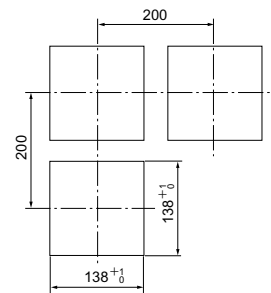

Unit :mm

Specifications subject to change without notice. Printed in Japan (I) 2012. 6

CHINO CORPORATION

32-8 KUMANO-CHO, ITABASHI-KU, TOKYO 173-8632

Telephone : +81-3-3956-2171

Facsimile : +81-3-3956-0915

E-mail : inter@chino.co.jp

Website : www.chino.co.jp/